



Ax1



Bx1



Cx2

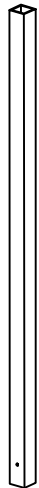

G1x4

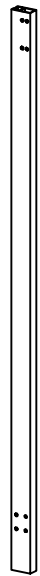

Dx2



Ex2



Fx2



Gx2



Hx1

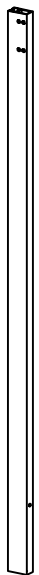

Ix1

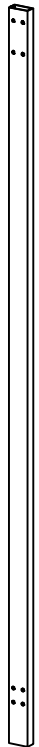

Jx1



J1x1



Kx1



K1x1



Lx5



Mx5



Px10

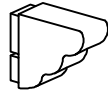

Qx14

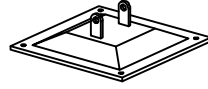

Rx4



Sx1

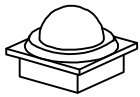

Ux4

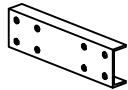

Wx4

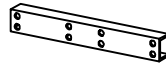

Xx3



M6x40mm

Yx32



M6x15mm

ax90



M6x80mm

bx6



M6

dx104



fx16



①

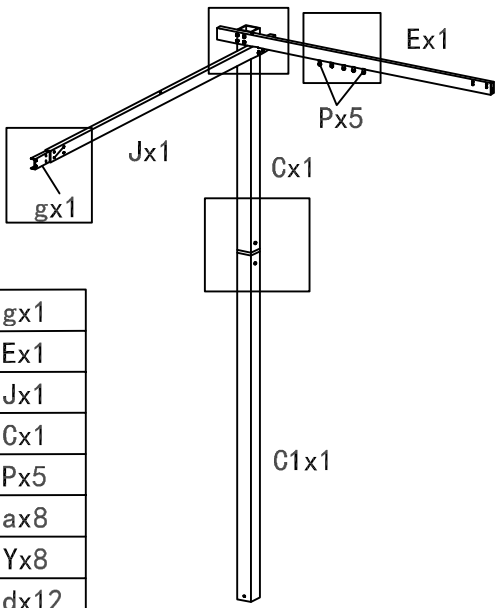

gx1
Ex1
Jx1
Cx1
Px5
ax8
Yx8
dx12

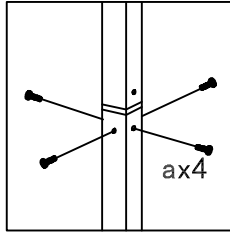
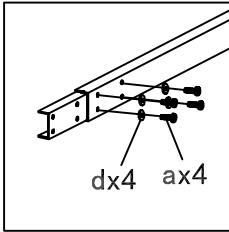
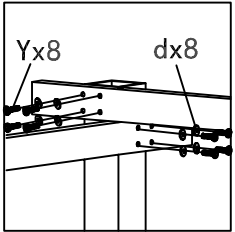

②

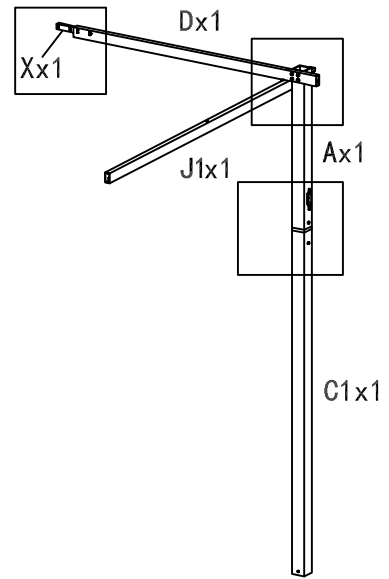

J1x1
Xx1
Dx1
Ax1
Yx8
ax8
dx12

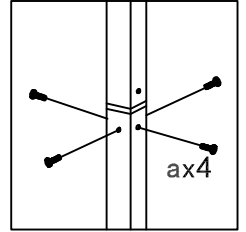
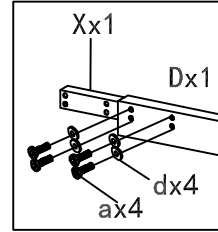
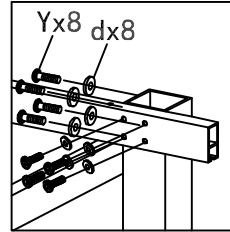

③

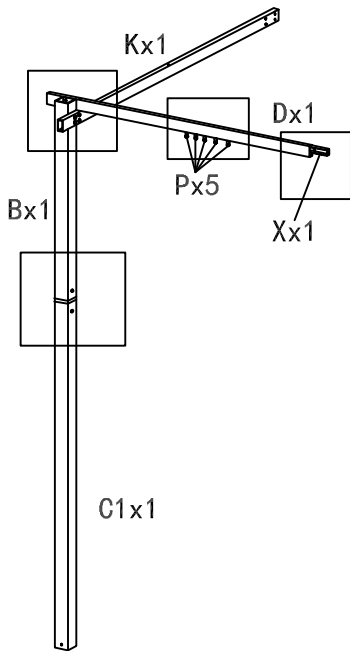

Kx1
Xx1
Dx1
Bx1
Px5
Yx8
dx12
ax8

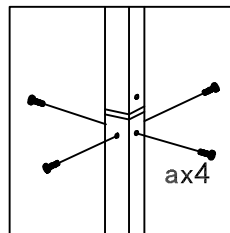
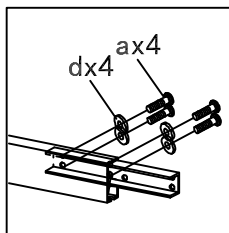
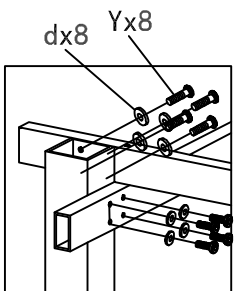

④

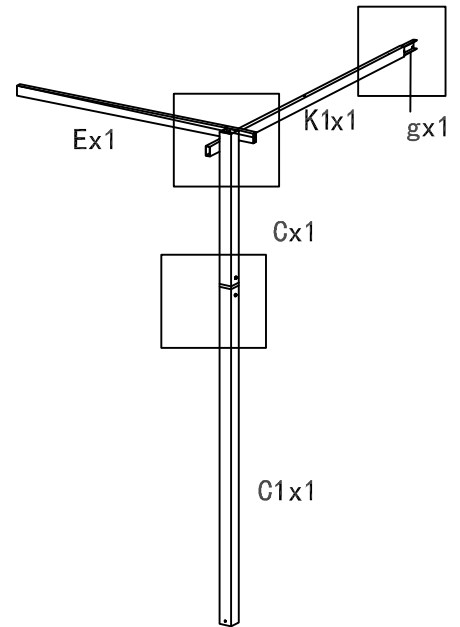

gx1
Ex1
K1x1
Cx1
ax8
Yx8
dx12

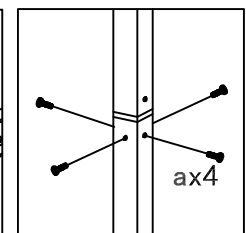
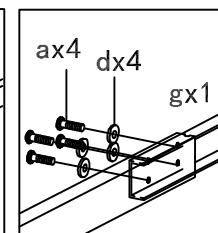
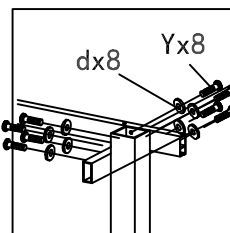

5

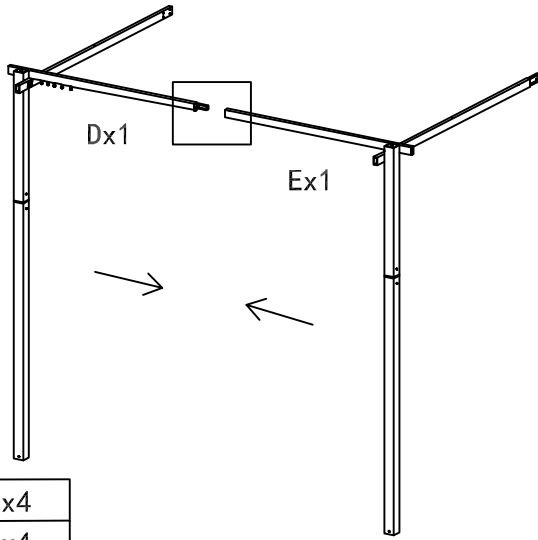

ax4
dx4

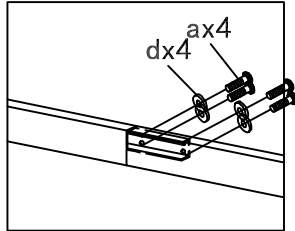
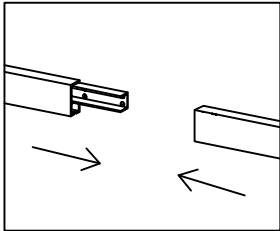

6

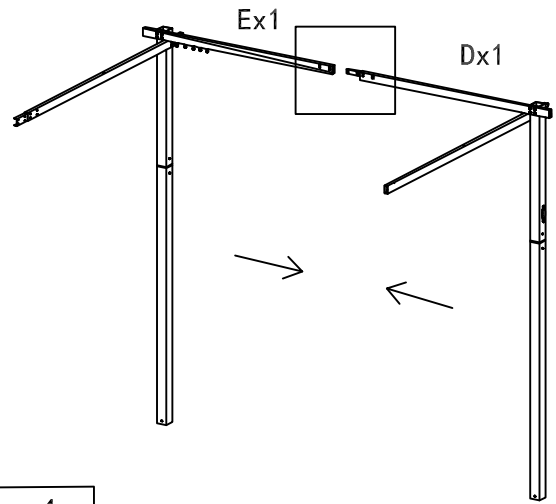

ax4
dx4

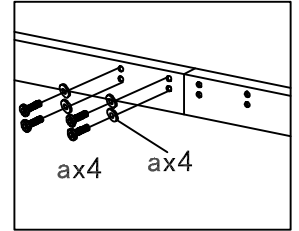
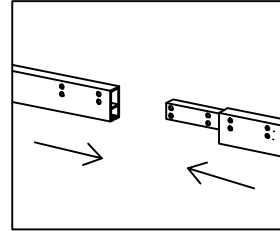

7

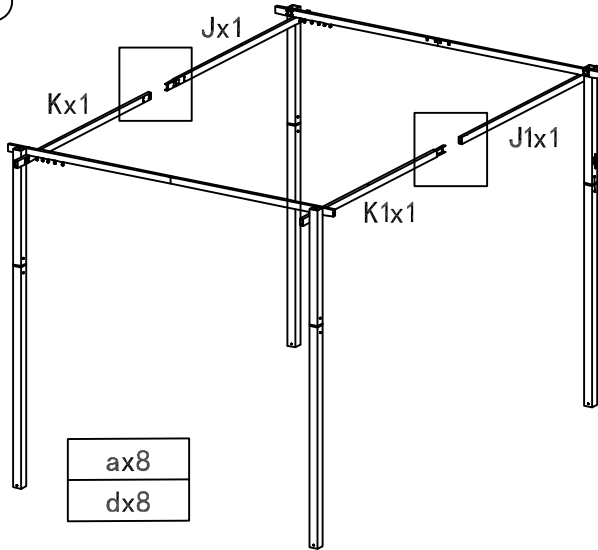

ax8
dx8

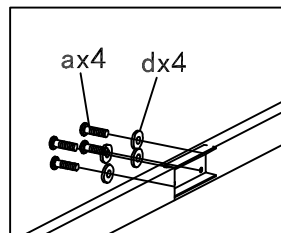
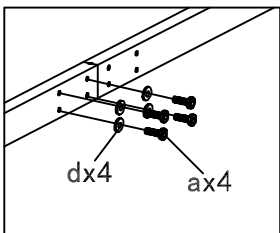

8

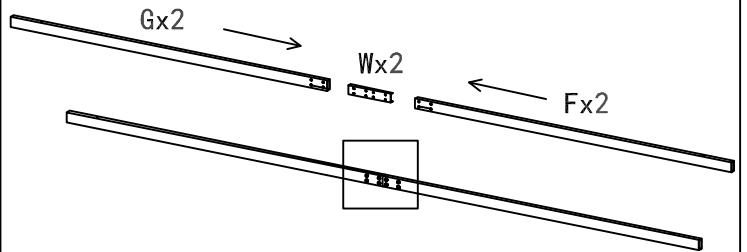

Gx2
Fx2
Wx2
ax16
dx16

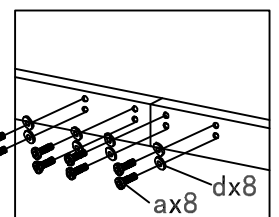
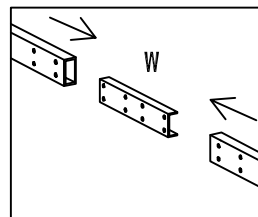

9

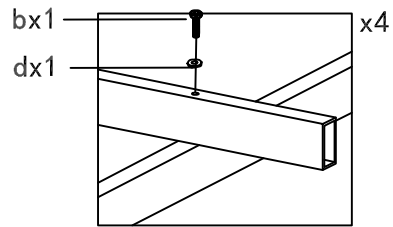
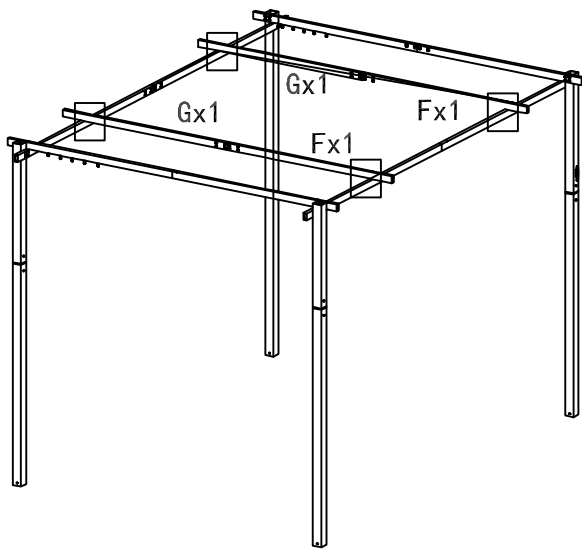

bx4
dx4

10

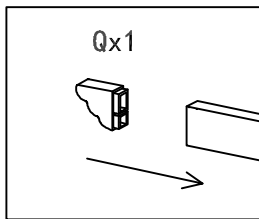
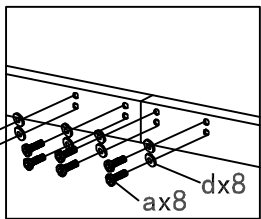
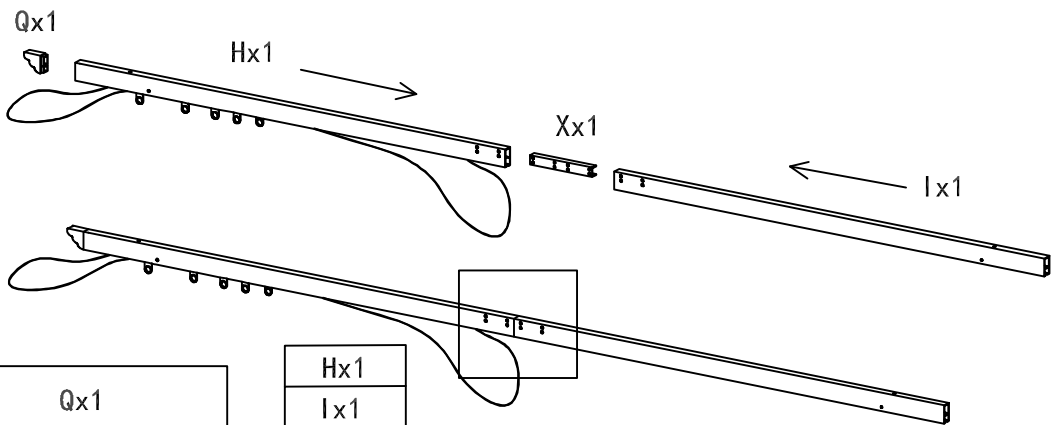
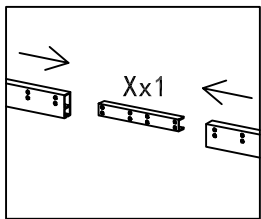

Hx1
Ix1
Xx1
ax8
dx8
Qx1

11

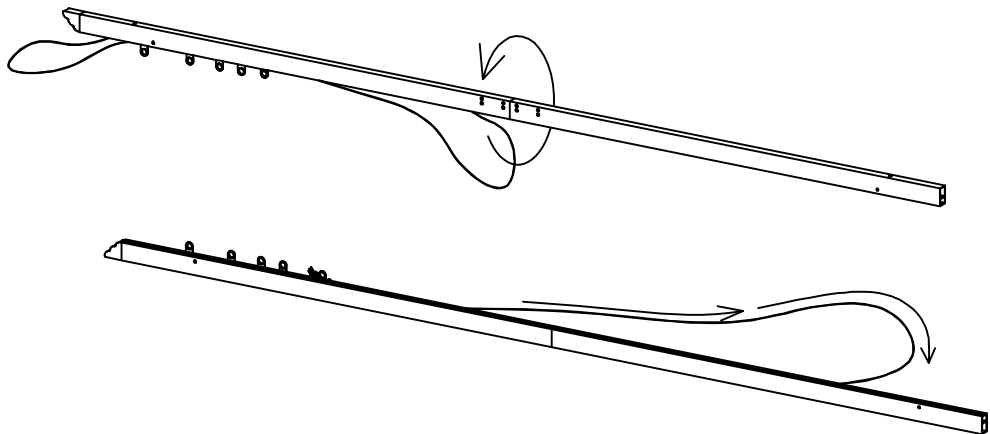

12

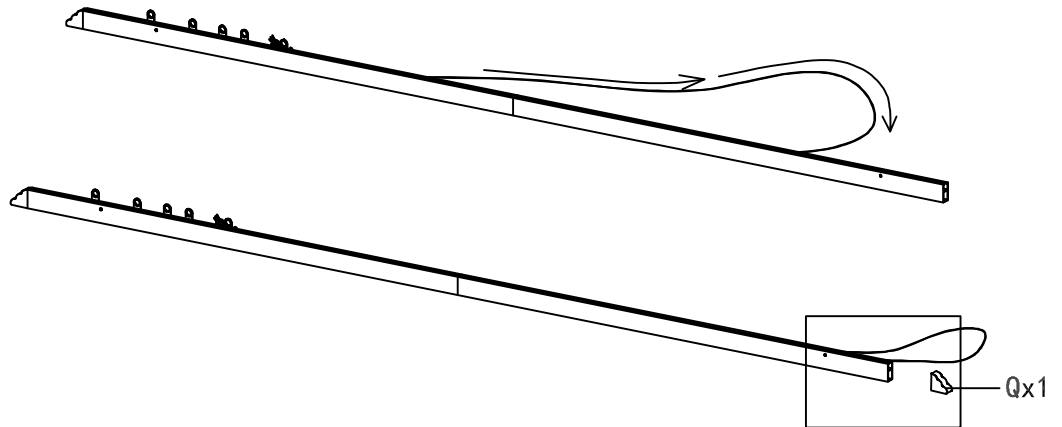
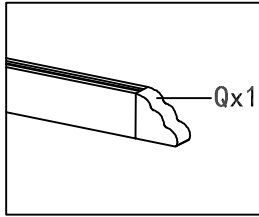
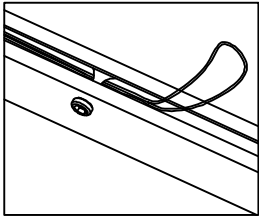

13

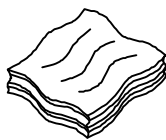

Nx1

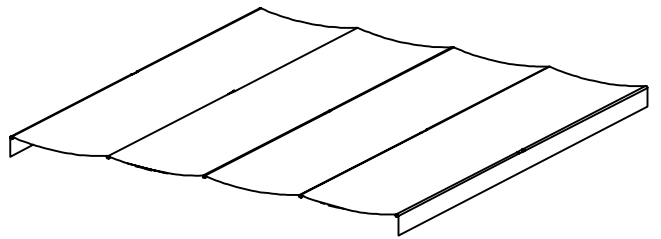

Nx4

14

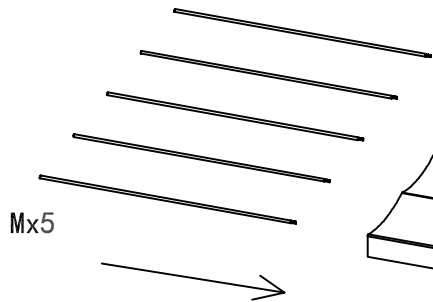

Mx5

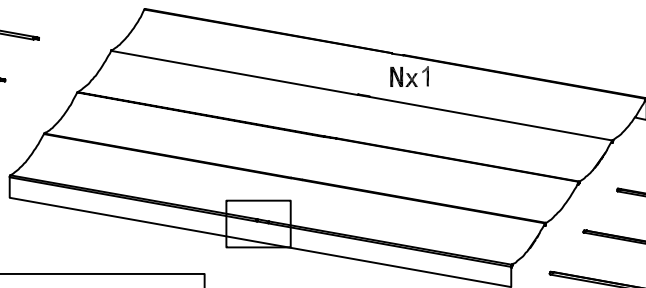

Nx1

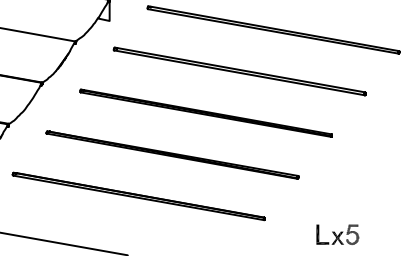

Lx5

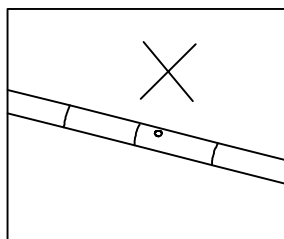
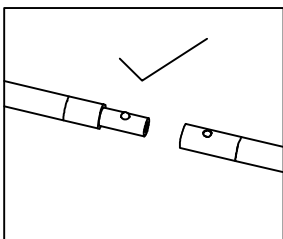

Mx5
Lx5

15

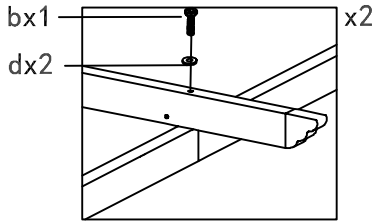
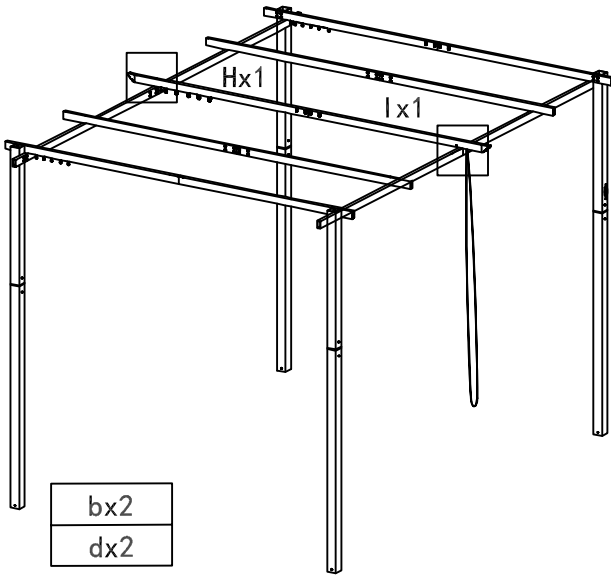

16

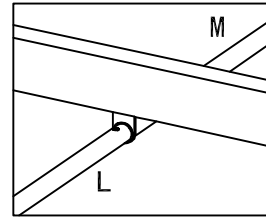
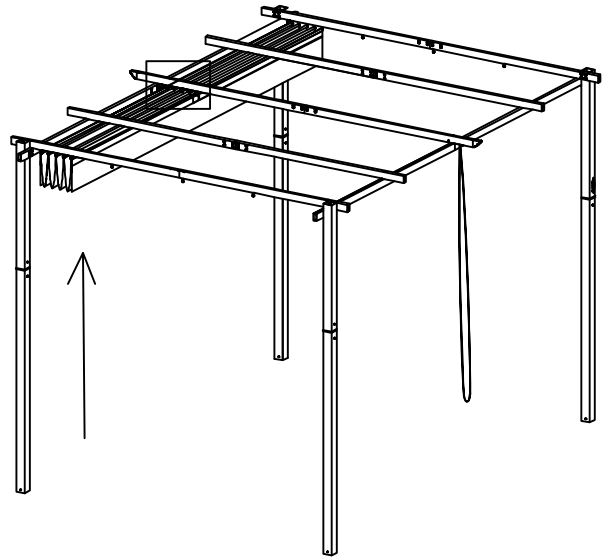

17

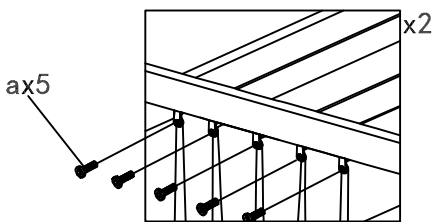
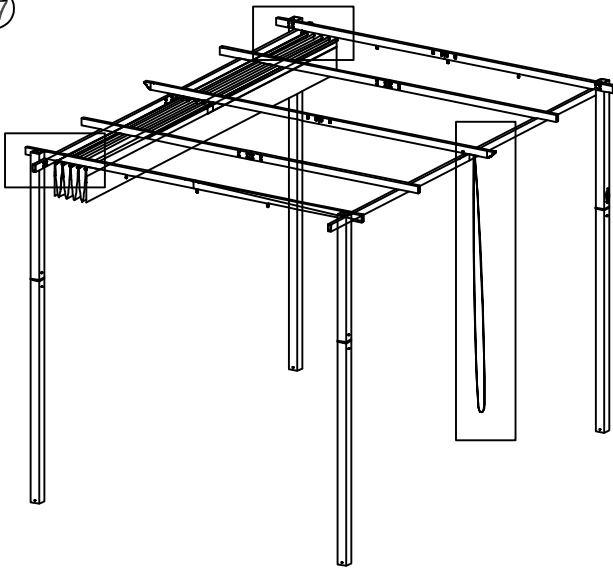

ax10

18

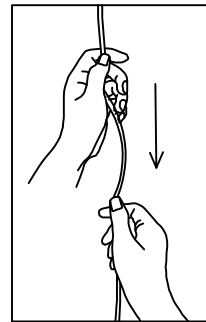
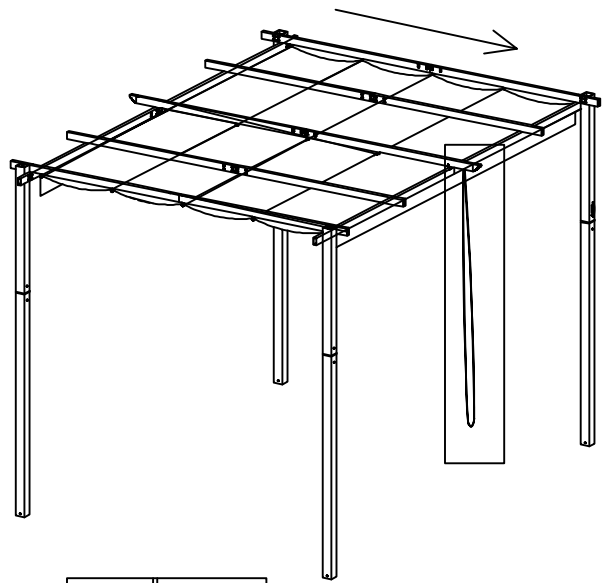

19

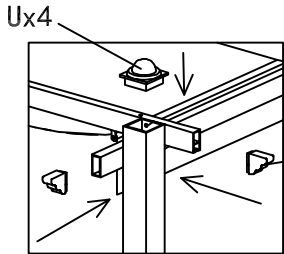
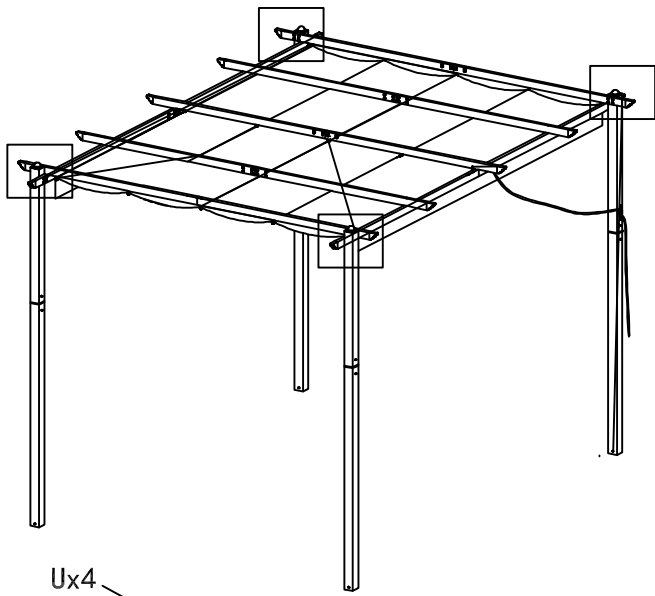

Qx12

Qx12
Ux4

20

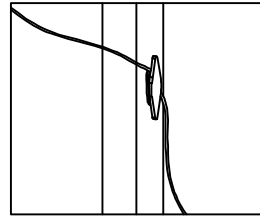
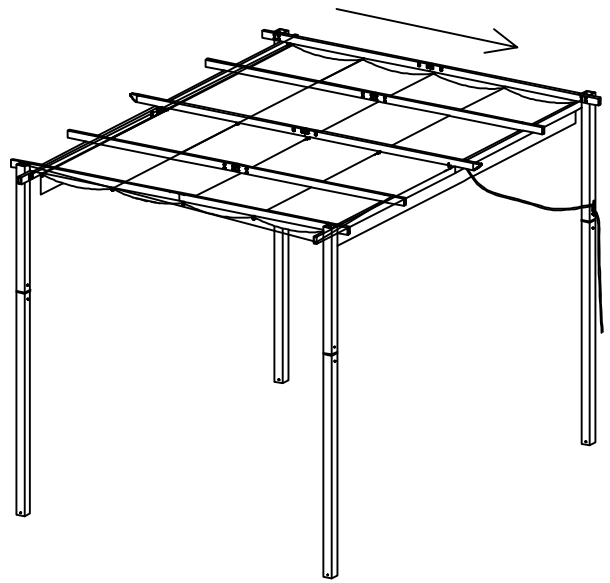

21

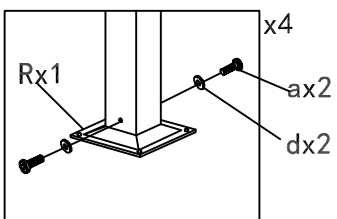
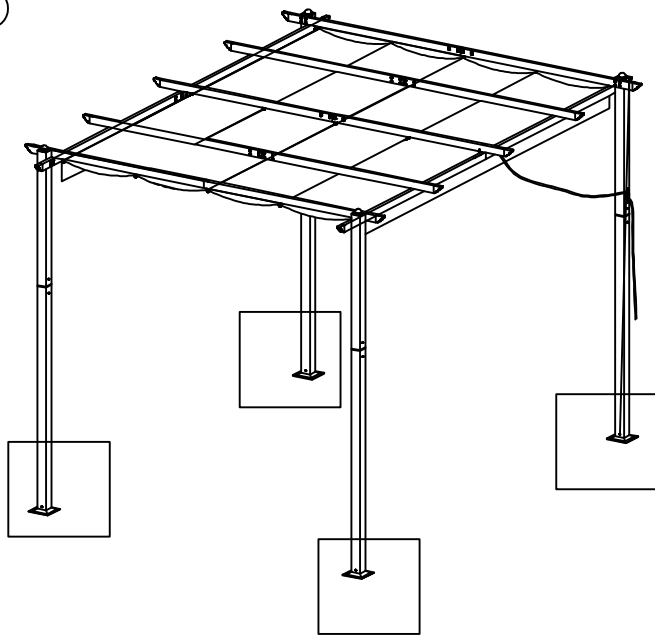

x4

Rx1

ax2

dx2

ax8
dx8
Rx4

22

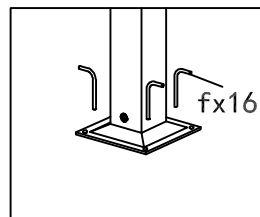
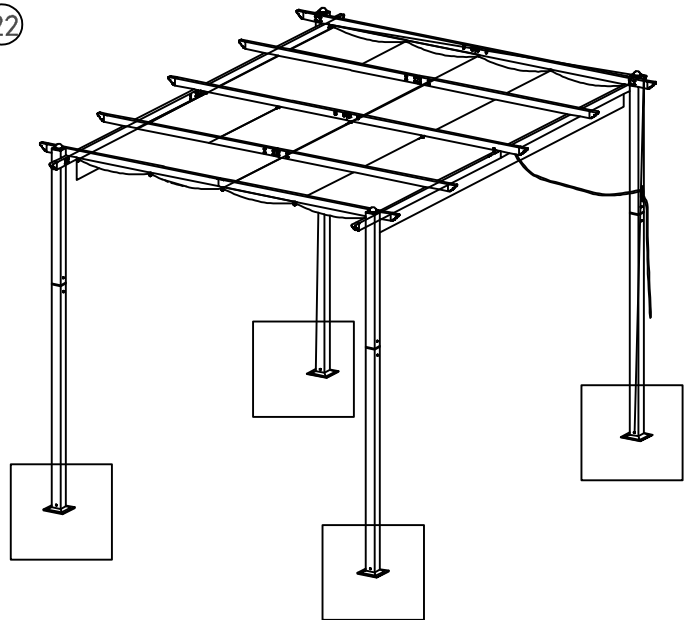

x4

fx16

fx16
