

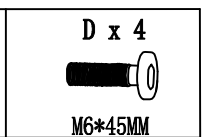

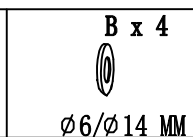

HARDWARE

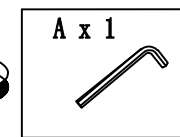

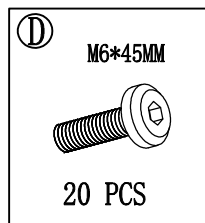
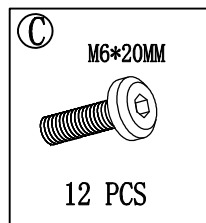
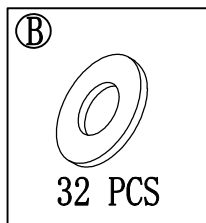
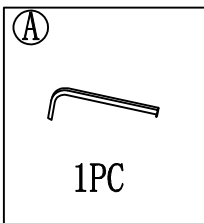
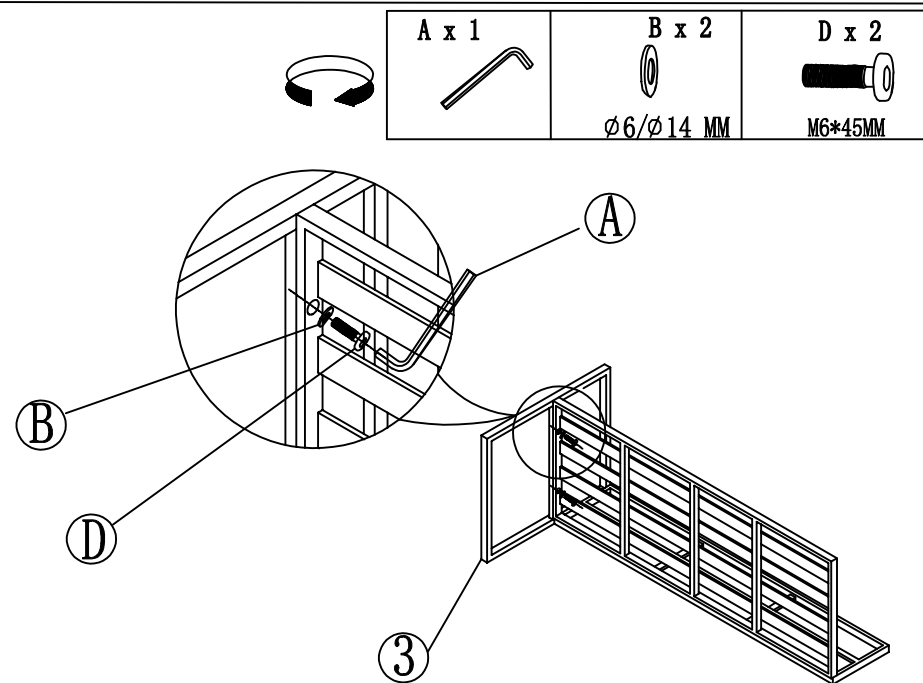
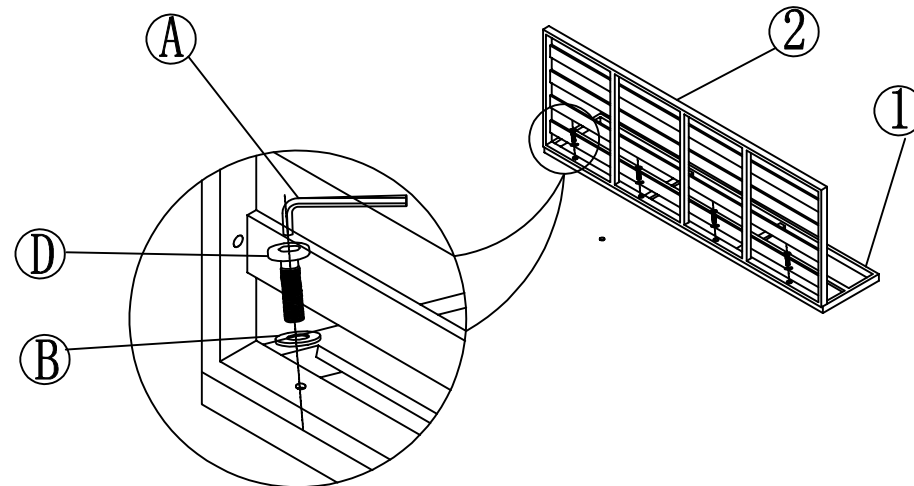
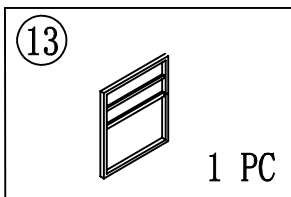
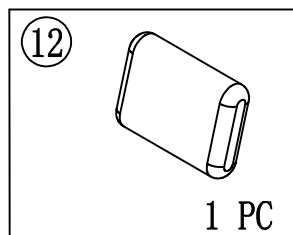
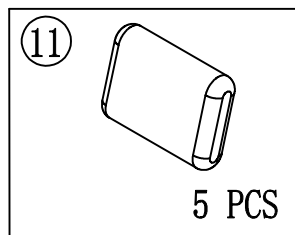
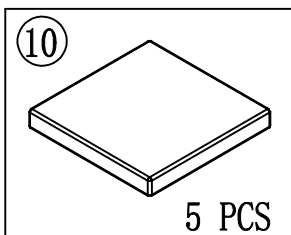
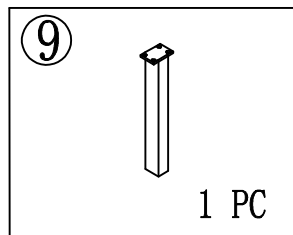
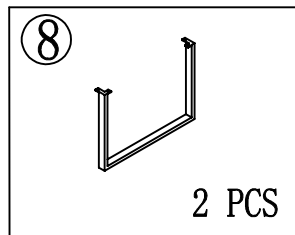
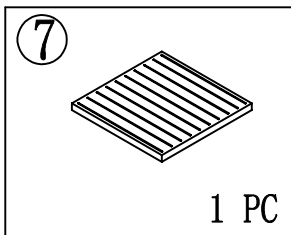
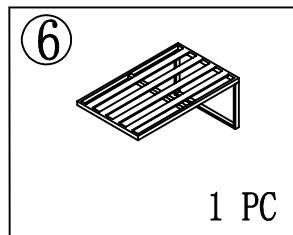
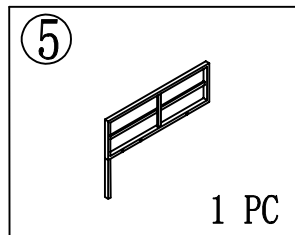
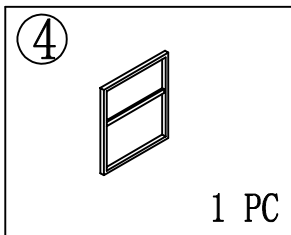
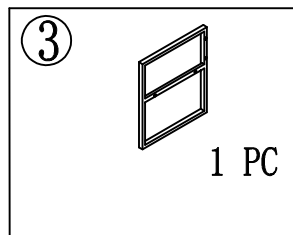
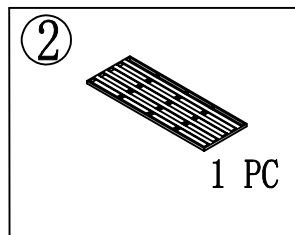
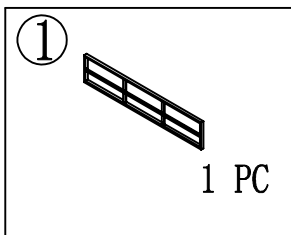

PARTS



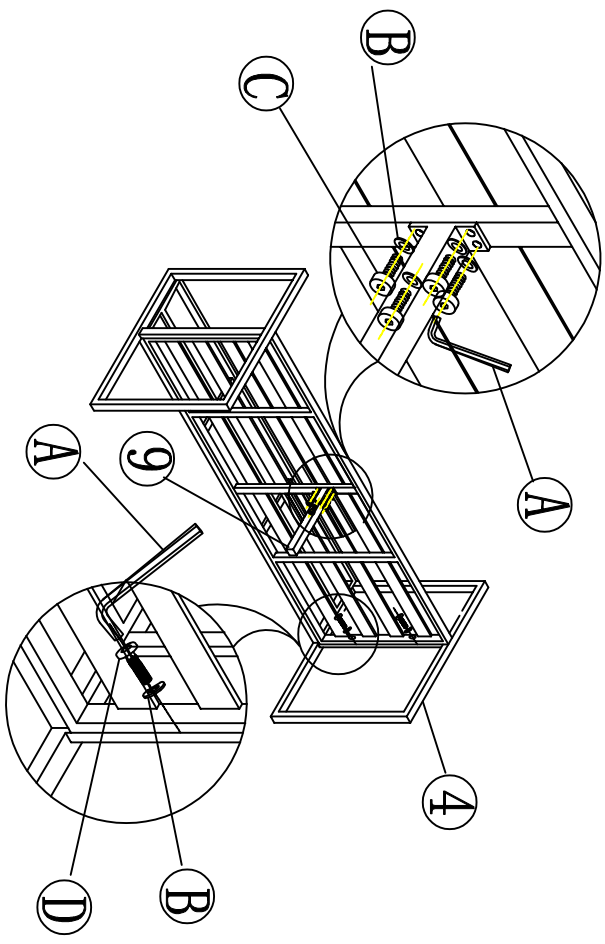

	A x 1		B x 6		C x 4		D x 2
		$\phi 6/\phi 14$ MM		M6*20MM		M6*45MM	



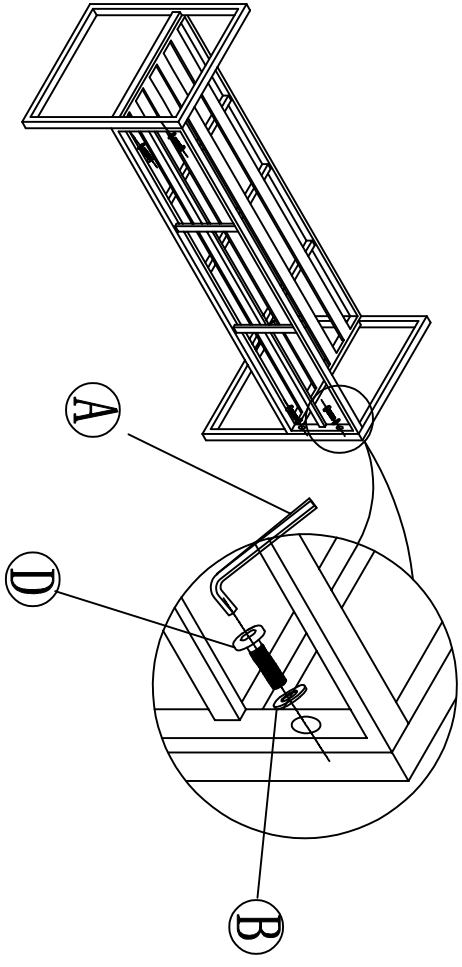

	A x 1		B x 4		D x 4
		$\phi 6/\phi 14$ MM		M6*45MM	



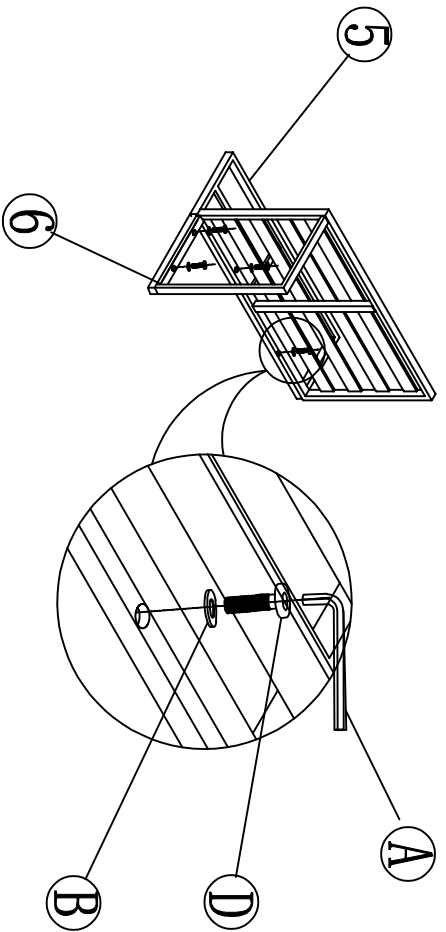

	A x 1		B x 4		D x 4
		$\phi 6/\phi 14$ MM		M6*45MM	



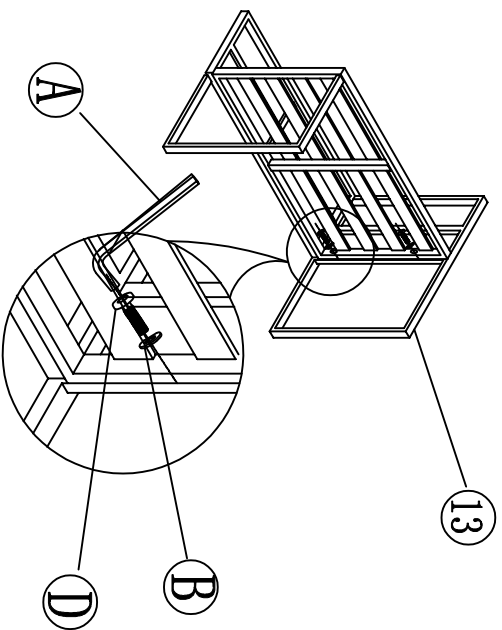

	A x 1		B x 2		D x 2
		$\phi 6/\phi 14$ MM		M6*45MM	

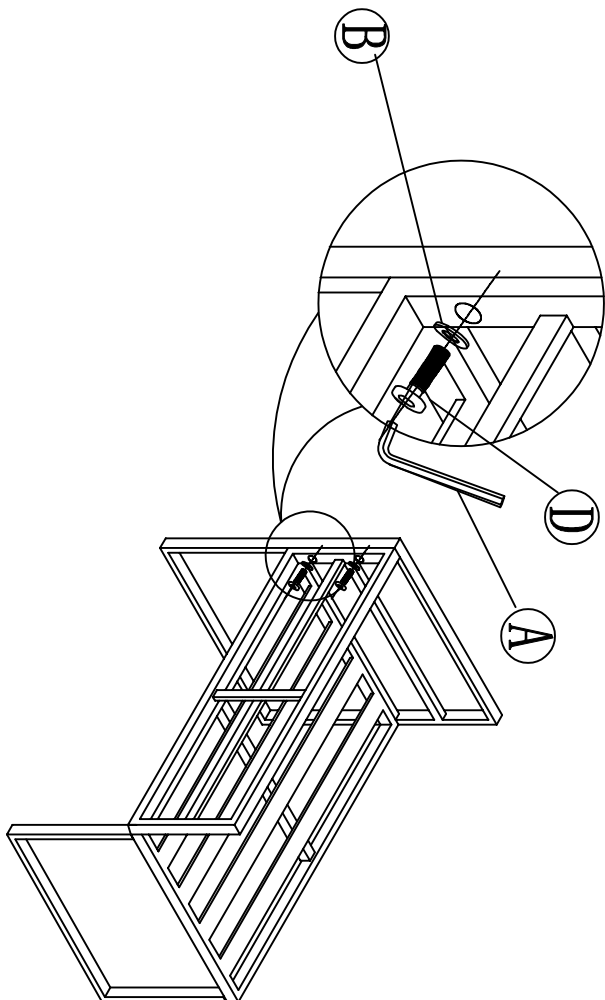

A x 1	B x 2	D x 2
		
	ø6/ø14 MM	M6*45MM



A x 1	B x 8	C x 8
		
	ø6/ø14 MM	M6*20MM

